

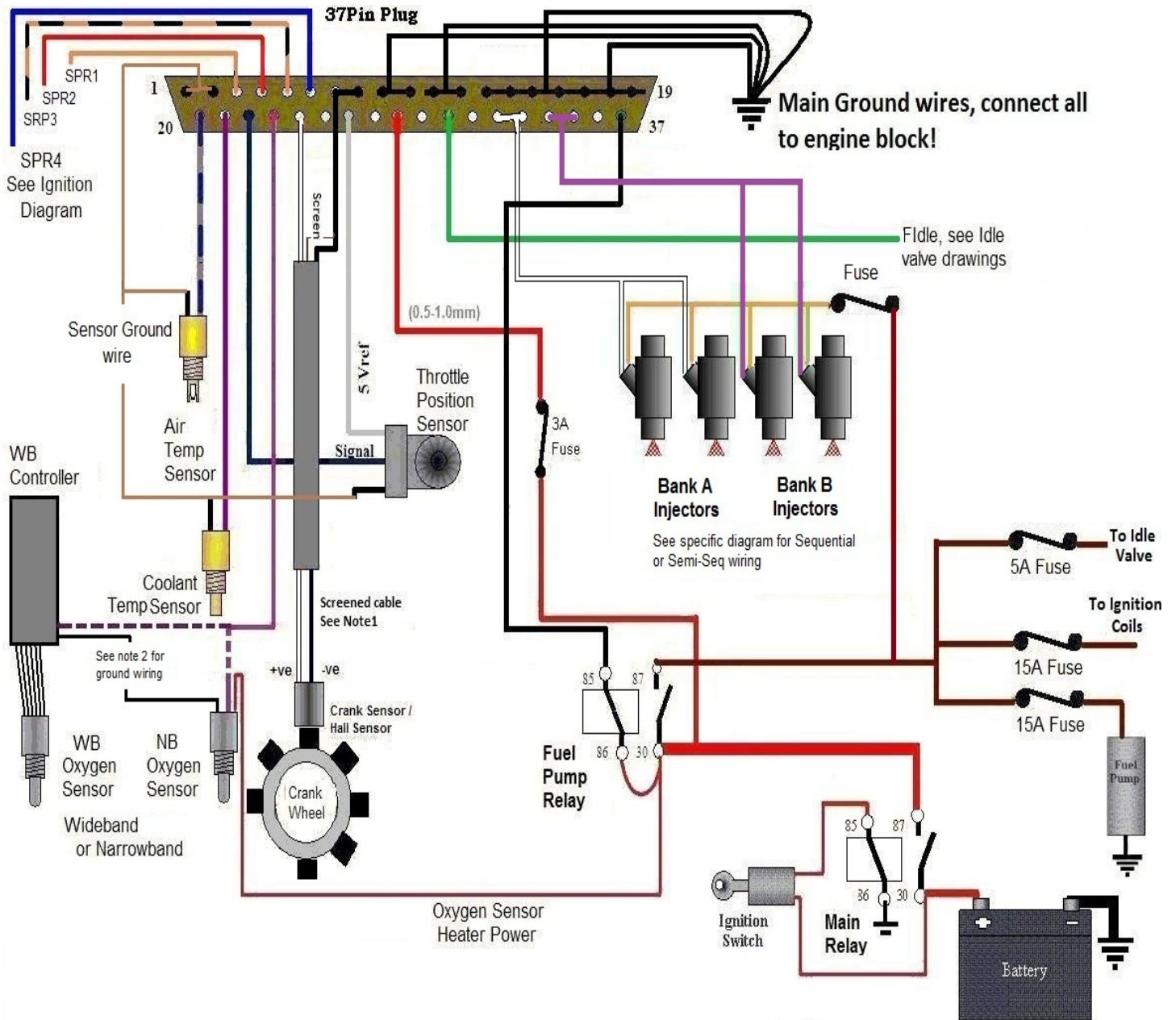











ExtraEFI Wiring Diagram.



 Pin 20 Grey/Blue Air Temp Sensor	 Pin 28 Red - +12V Ignition 0.5 - 1.0mm
 Pin 21 Purple - Coolant Temp Sensor	 Pin 30 Green - Idle Valve
 Pin 22 Blue - TPS Signal	 Pin 32,33 White - Injector Bank 1 0.5 - 1.0mm
 Pin 23 Pink - Oxygen Sensor	 Pin 34,35 Purple - Injector Bank 2 0.5 - 1.0mm
 Pin 26 Grey - 5V for TPS	 Pin 37 Black - Fuel Pump Relay

Pins 3-6 = SPR 1-4
 These are for additional options, see bottom of the ECU for details

 Pin 3 Orange - SPR1	 Pin 5 Orange/Black - SPR3
 Pin 4 Red - SPR2	 Pin 6 Blue - SPR4 0.5 - 1.0mm

Note1:

Screened cable is earthed at the MS ECU end of the loom. Please leave this insulated at the sensor end, simply connect the white and (black/blue) cables within the screened cable.

The white/red cable, in the screen, is the signal cable, the black/blue cable is ground.

Note2:

See the **Basic Wiring** file for more on how to connect the lambda grounds, power and heater grounds go to the chassis, output and analogue grounds go to the Sensor Ground cable in the MS loom.

If using Ford EDIS (12 pinned module) then the screened cable goes to the PIP output of the module, not the VR sensor!!

The diagram shows the fuel pump relay providing power to the ignition coils, idle valve, etc. this is a good idea to protect the ECU whilst setting it up as power only gets to the drive components when the ECU sees an RPM.

See the relevant ignition diagram for wiring your coils.

www.ExtraEFI.co.uk